

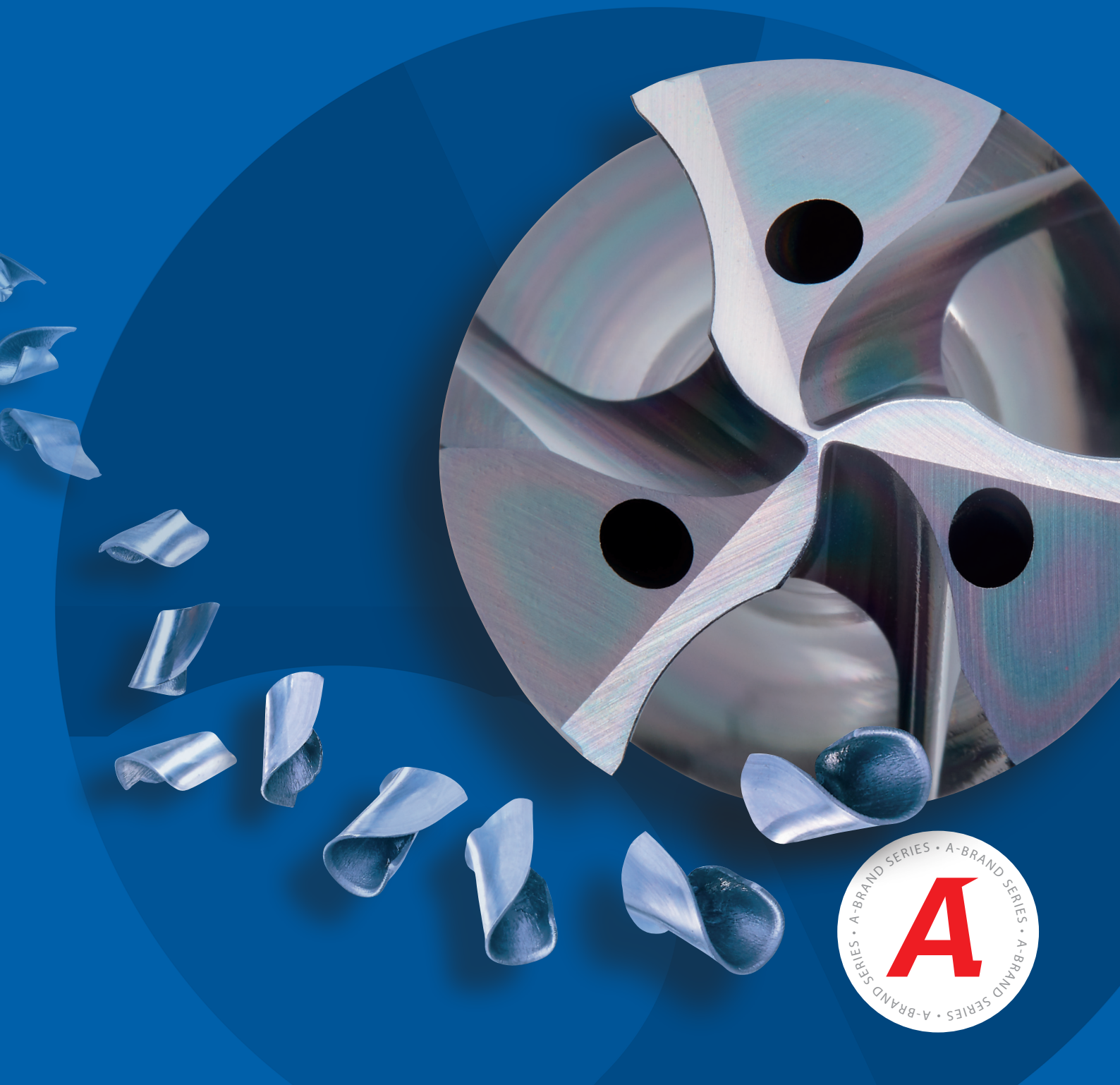

Coolant-through, 3-fluted carbide drill series

ADO-TRS & TRS-HO-10D

Volume 2



KEY FEATURES: ADO-TRS

1 3 flutes

2 Coolant through

3 Feed up to 10% of
drill diameter

4 0,1 increment in sizes 3D & 5D



3-FLUTES CARBIDE DRILL WITH OIL HOLE

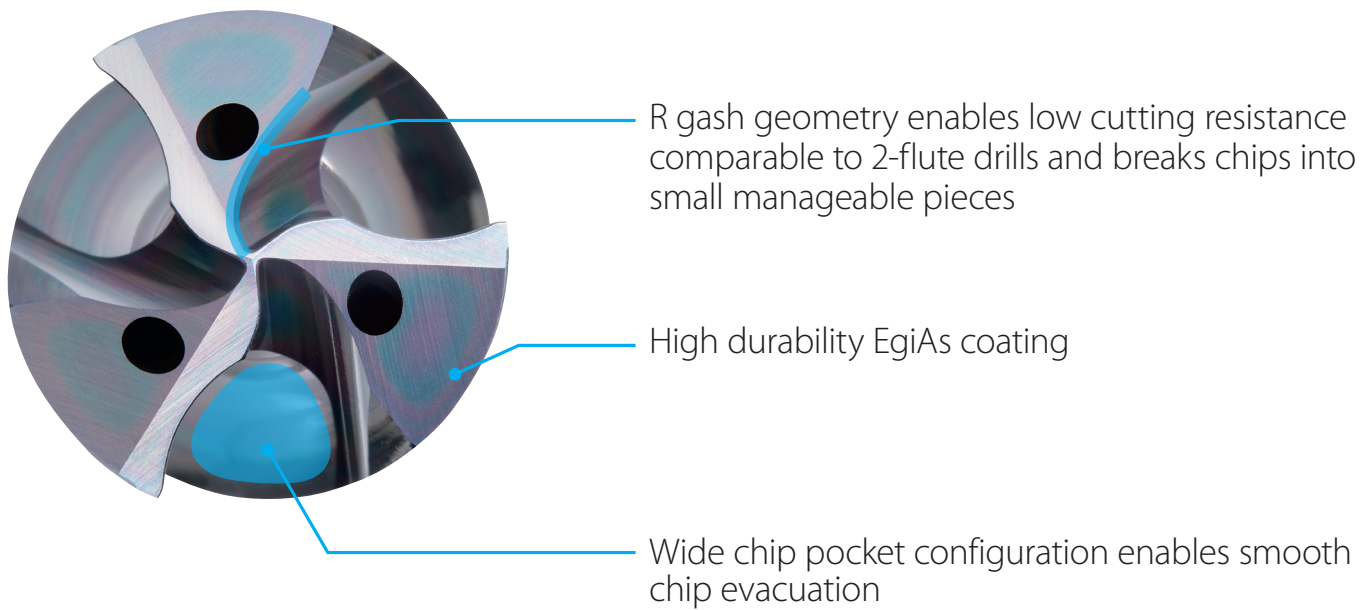

High thrust force ADO-TRS enables low resistance drilling

Reduces thrust force by over 30% against a competitor 3-flute drill with even lower thrust force versus a competitor 2-flute drill

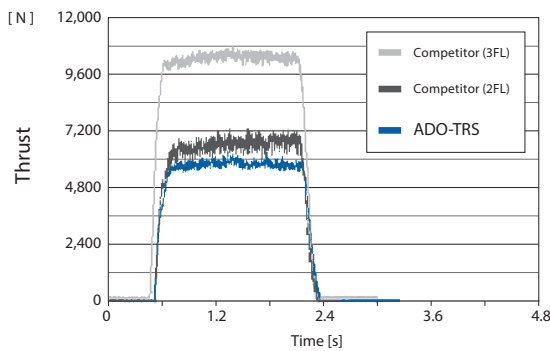

Poor Chip Evacuation

ADO-TRS offers outstanding chip management capability and consistent chip form

Chips from the competitor 3-flute and 2-flute drills are elongated and are the common cause of chip evaluation troubles

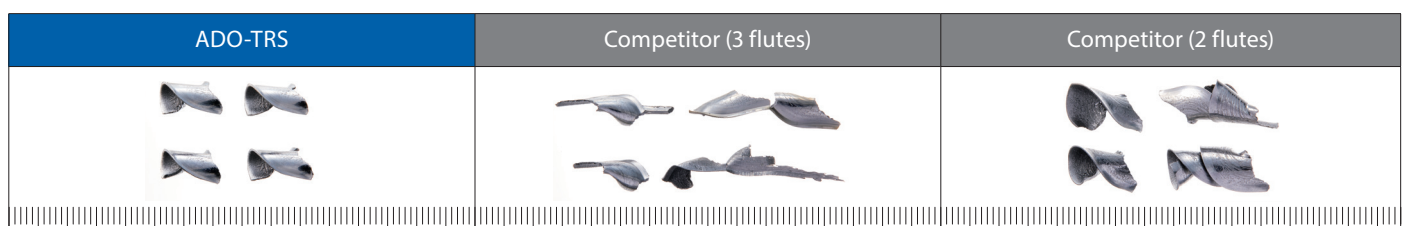

Work Material: S50C



ADO-TRS-3D

Drilling | Solid carbide | 3xD

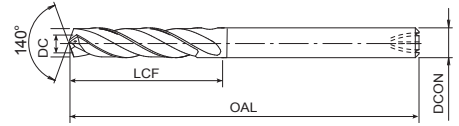
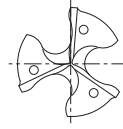

- First choice in quality and performance
- 3 flute carbide drill with internal coolant, EgiAs coating
- Up to 3xD
- Allows high feed 1.000mm/min process in steel and cast iron
- 112 sizes

P $C < 0,2\%$	P $0,25 < C < 0,4$	P $C \geq 0,45\%$	P SCM	M INOX	K GG	K GGG	S Ti	H 25-35 HRC	H 35-45 HRC	H 45-52 HRC
----------------------	---------------------------	--------------------------	--------------	---------------	-------------	--------------	-------------	--------------------	--------------------	--------------------

A	CARBIDE	EgiAs	30°	SHRINK FIT		140°	h8
----------	----------------	--------------	------------	-------------------	--	-------------	-----------

EDP	DC	LCF	OAL	DCON	EDP	DC	LCF	OAL	DCON
8720300	3	18	66	3	8720850	8,5	43	101	10
8720330	3,3	20	74	4	8720860	8,6	43	101	10
8720350	3,5	21	74	4	8720870	8,7	44	101	10
8720366	3,66	22	74	4	8720880	8,8	44	101	10
8720400	4	24	74	4	8720890	8,9	45	101	10
8720420	4,2	26	80	6	8720900	9	45	101	10
8720450	4,5	27	80	6	8720910	9,1	46	106	10
8720460	4,6	28	80	6	8720920	9,2	46	106	10
8720500	5	25	80	6	8720925	9,25	47	106	10
8720510	5,1	26	82	6	8720930	9,3	47	106	10
8720520	5,2	26	82	6	8720938	9,38	47	106	10
8720530	5,3	27	82	6	8720940	9,4	47	106	10
8720540	5,4	27	82	6	8720950	9,5	48	106	10
8720550	5,5	28	82	6	8720960	9,6	48	106	10
48323555	5,55	28	82	6	8720970	9,7	49	106	10
8720560	5,6	28	82	6	8720980	9,8	49	106	10
8720570	5,7	29	82	6	8720990	9,9	50	106	10
8720580	5,8	29	82	6	8721000	10	50	106	10
8720590	5,9	30	82	6	8721010	10,1	51	113	12
8720600	6	30	82	6	8721020	10,2	51	113	12
8720610	6,1	31	88	8	8721030	10,3	52	113	12
8720620	6,2	31	88	8	8721040	10,4	52	113	12
8720630	6,3	32	88	8	8721050	10,5	53	113	12
8720640	6,4	32	88	8	8721060	10,6	53	113	12
8720650	6,5	33	88	8	8721070	10,7	54	113	12
8720660	6,6	33	88	8	8721080	10,8	54	113	12
8720670	6,7	34	88	8	8721090	10,9	55	113	12
8720680	6,8	34	88	8	8721100	11	55	113	12
8720690	6,9	35	88	8	8721110	11,1	56	120	12
8720700	7	35	88	8	8721120	11,2	56	120	12
8720710	7,1	36	94	8	8721125	11,25	57	120	12
8720720	7,2	36	94	8	8721130	11,3	57	120	12
8720730	7,3	37	94	8	8721138	11,38	57	120	12
8720738	7,38	37	94	8	8721140	11,4	57	120	12
8720740	7,4	37	94	8	8721150	11,5	58	120	12
48323745	7,45	38	94	8	8721160	11,6	58	120	12
8720750	7,5	38	94	8	8721170	11,7	59	120	12
8720760	7,6	38	94	8	8721180	11,8	59	120	12
8720770	7,7	39	94	8	8721190	11,9	60	120	12
8720780	7,8	39	94	8	8721200	12	60	120	12
8720790	7,9	40	94	8	8721250	12,5	63	128	14
8720800	8	40	94	8	8721300	13	65	128	14
8720810	8,1	41	101	10	8721325	13,25	67	134	14
8720820	8,2	41	101	10	8721330	13,3	67	134	14
8720830	8,3	42	101	10	8721338	13,38	67	134	14
8720840	8,4	42	101	10	8721350	13,5	68	134	14

Drilling | Solid carbide

3xD

ADO-TRS-5D

Drilling | Solid carbide | 5xD

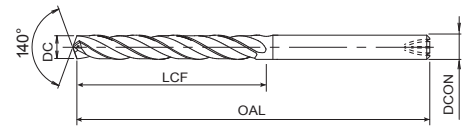
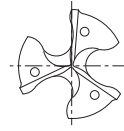

- First choice in quality and performance
- 3 flute carbide drill with internal coolant, EgiAs coating
- Up to 5xD
- Allows high feed 1.000mm/min process in steel and cast iron
- 112 sizes



EDP	DC	LCF	OAL	DCON	EDP	DC	LCF	OAL	DCON
8722300	3	27	78	3	8722850	8,5	68	128	10
8722330	3,3	30	86	4	8722860	8,6	69	128	10
8722350	3,5	32	86	4	8722870	8,7	70	128	10
8722366	3,66	33	86	4	8722880	8,8	71	128	10
8722400	4	36	86	4	8722890	8,9	72	128	10
8722420	4,2	38	95	6	8722900	9	72	128	10
8722450	4,5	41	95	6	8722910	9,1	73	136	10
8722460	4,6	42	95	6	8722920	9,2	74	136	10
8722500	5	45	95	6	8722925	9,25	74	136	10
8722510	5,1	41	100	6	8722930	9,3	75	136	10
8722520	5,2	42	100	6	8722938	9,38	76	136	10
8722530	5,3	43	100	6	8722940	9,4	76	136	10
8722540	5,4	44	100	6	8722950	9,5	76	136	10
8722550	5,5	44	100	6	8722960	9,6	77	136	10
48324555	5,55	45	100	6	8722970	9,7	78	136	10
8722560	5,6	45	100	6	8722980	9,8	79	136	10
8722570	5,7	46	100	6	8722990	9,9	80	136	10
8722580	5,8	47	100	6	8723000	10	80	136	10
8722590	5,9	48	100	6	8723010	10,1	81	146	12
8722600	6	48	100	6	8723020	10,2	82	146	12
8722610	6,1	49	109	8	8723030	10,3	83	146	12
8722620	6,2	50	109	8	8723040	10,4	84	146	12
8722630	6,3	51	109	8	8723050	10,5	84	146	12
8722640	6,4	52	109	8	8723060	10,6	85	146	12
8722650	6,5	52	109	8	8723070	10,7	86	146	12
8722660	6,6	53	109	8	8723080	10,8	87	146	12
8722670	6,7	54	109	8	8723090	10,9	88	146	12
8722680	6,8	55	109	8	8723100	11	88	146	12
8722690	6,9	56	109	8	8723110	11,1	89	156	12
8722700	7	56	109	8	8723120	11,2	90	156	12
8722710	7,1	57	118	8	8723125	11,25	90	156	12
8722720	7,2	58	118	8	8723130	11,3	91	156	12
8722730	7,3	59	118	8	8723138	11,38	92	156	12
8722738	7,38	60	118	8	8723140	11,4	92	156	12
8722740	7,4	60	118	8	8723150	11,5	92	156	12
48324745	7,45	60	118	8	8723160	11,6	93	156	12
8722750	7,5	60	118	8	8723170	11,7	94	156	12
8722760	7,6	61	118	8	8723180	11,8	95	156	12
8722770	7,7	62	118	8	8723190	11,9	96	156	12
8722780	7,8	63	118	8	8723200	12	96	156	12
8722790	7,9	64	118	8	8723250	12,5	100	167	14
8722800	8	64	118	8	8723300	13	104	167	14
8722810	8,1	65	128	10	8723325	13,25	106	176	14
8722820	8,2	66	128	10	8723330	13,3	107	176	14
8722830	8,3	67	128	10	8723338	13,38	108	176	14
8722840	8,4	68	128	10	8723350	13,5	108	176	14

Drilling | Solid carbide

5xD

ADO-TRS-5D

Drilling | Solid carbide | 5xD

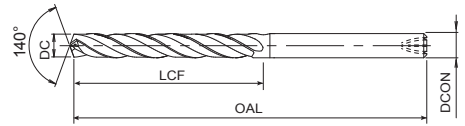
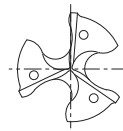

- First choice in quality and performance
- 3 flute carbide drill with internal coolant, EgiAs coating
- Up to 5xD
- Allows high feed 1.000mm/min process in steel and cast iron
- 112 sizes

P C < 0,2%
P 0,25 < C < 0,4
P C ≥ 0,45%
P SCM
M INOX
K GG
K GGG
H 25-35 HRC

A
CARBIDE
EgiAs
 30°
 SHRINK FIT

 140°
 h8

EDP	DC	LCF	OAL	DCON
8723400	14	112	176	14
8723410	14,1	113	185	16
8723420	14,2	114	185	16
8723430	14,3	115	185	16
8723450	14,5	116	185	16
8723500	15	120	185	16
8723520	15,2	122	193	16
8723530	15,3	123	193	16
8723550	15,5	124	193	16
8723600	16	128	193	16
8723650	16,5	132	201	18
8723700	17	136	201	18
8723725	17,25	138	209	18
8723750	17,5	140	209	18
8723800	18	144	209	18
8723850	18,5	148	217	20
8723900	19	152	217	20
8723925	19,25	154	225	20
8723950	19,5	156	225	20
8724000	20	160	225	20

EDP	DC	LCF	OAL	DCON

5xD Drilling | Solid carbide



TRS-HO-10D

Drilling | Solid carbide | 10xD

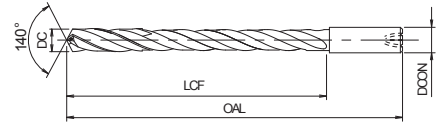
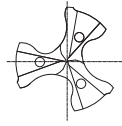

- First choice in quality and performance
- 3 flute carbide drill with internal coolant, WDI coating
- Up to 10xD
- Allows high feed 1.000mm/min process in steel and cast iron
- 11 sizes

P C < 0,2%	P 0,25 < C < 0,4	P C ≥ 0,45%	P SCM	K GG	K GGG
----------------------	----------------------------	-----------------------	-----------------	----------------	-----------------

A	CARBIDE	WDI	30°	SHRINK FIT	140°	h8
----------	----------------	------------	------------	-------------------	-------------	-----------

EDP	DC	LCF	OAL	DCON	EDP	DC	LCF	OAL	DCON
48159050	5	65	115	6					
8664055	5,5	78	128	6					
8664060	6	78	128	6					
48159065	6,5	87	140	8					
48159070	7	90	140	8					
8664075	7,5	100	155	8					
8664080	8	105	155	8					
48159085	8,5	110	165	10					
48159090	9	115	165	10					
8664100	10	130	190	10					
8664120	12	155	215	12					

Drilling | Solid carbide

10xD

CUTTING CONDITIONS

Drilling | Solid | Cutting conditions

ADO-TRS-3D/5D

Vc	Mild Steel - Low Carbon Steel SS400 - S10C ~150HB ~500 N/mm ²		Carbon Steel S35C - S50C ~210HB ~710 N/mm ²		Alloy Steel SCM - SCr - sncm 710 ~900 N/mm ²	
	80 ~ 120 m/min		80 ~ 120 m/min		60 ~ 100 m/min	
Ø	S (min ⁻¹)	F (mm/rev.)	S (min ⁻¹)	F (mm/rev.)	S (min ⁻¹)	F (mm/rev.)
3	10.000	0,11 ~ 0,15	10.000	0,11 ~ 0,15	8.500	0,11 ~ 0,15
4	8.000	0,14 ~ 0,2	8.000	0,14 ~ 0,2	6.400	0,14 ~ 0,2
5	6.400	0,18 ~ 0,25	6.400	0,18 ~ 0,25	5.100	0,18 ~ 0,25
6	5.300	0,21 ~ 0,3	5.300	0,21 ~ 0,3	4.200	0,21 ~ 0,3
7	4.500	0,25 ~ 0,35	4.500	0,25 ~ 0,35	3.600	0,25 ~ 0,35
8	4.000	0,28 ~ 0,4	4.000	0,28 ~ 0,4	3.200	0,28 ~ 0,4
9	3.500	0,32 ~ 0,45	3.500	0,32 ~ 0,45	2.800	0,32 ~ 0,45
10	3.200	0,35 ~ 0,5	3.200	0,35 ~ 0,5	2.500	0,35 ~ 0,5
11	2.900	0,39 ~ 0,55	2.900	0,39 ~ 0,55	2.300	0,39 ~ 0,55
12	2.700	0,42 ~ 0,6	2.700	0,42 ~ 0,6	2.100	0,42 ~ 0,6
13	2.400	0,46 ~ 0,65	2.400	0,46 ~ 0,65	2.000	0,46 ~ 0,65
14	2.300	0,49 ~ 0,7	2.300	0,49 ~ 0,7	1.800	0,49 ~ 0,7
15	2.100	0,53 ~ 0,75	2.100	0,53 ~ 0,7	1.700	0,53 ~ 0,7
16	2.000	0,56 ~ 0,8	2.000	0,56 ~ 0,72	1.600	0,56 ~ 0,72
17	1.900	0,6 ~ 0,85	1.900	0,6 ~ 0,77	1.500	0,6 ~ 0,77
18	1.800	0,63 ~ 0,9	1.800	0,63 ~ 0,81	1.400	0,63 ~ 0,81
19	1.700	0,67 ~ 0,9	1.700	0,67 ~ 0,86	1.300	0,67 ~ 0,86
20	1.600	0,7 ~ 0,9	1.600	0,7 ~ 0,9	1.300	0,7 ~ 0,9

Vc	Alloy Steel SCM - SCr - sncm 900 ~1.100 N/mm ²		Cast Iron FC250 ~350N/mm ²		Ductile Cast Iron FCD450 - FCD600 400 ~600 N/mm ²	
	60 ~ 90 m/min		80 ~ 120 m/min		60 ~ 100 m/min	
Ø	S (min ⁻¹)	F (mm/rev.)	S (min ⁻¹)	F (mm/rev.)	S (min ⁻¹)	F (mm/rev.)
3	8.000	0,11 ~ 0,15	10.000	0,11 ~ 0,18	8.500	0,11 ~ 0,15
4	6.000	0,14 ~ 0,2	8.000	0,14 ~ 0,24	6.400	0,14 ~ 0,2
5	4.800	0,18 ~ 0,25	6.400	0,18 ~ 0,3	5.100	0,18 ~ 0,25
6	4.000	0,21 ~ 0,3	5.300	0,21 ~ 0,36	4.200	0,21 ~ 0,3
7	3.400	0,25 ~ 0,35	4.500	0,25 ~ 0,42	3.600	0,25 ~ 0,35
8	3.000	0,28 ~ 0,4	4.000	0,28 ~ 0,48	3.200	0,28 ~ 0,4
9	2.700	0,32 ~ 0,45	3.500	0,32 ~ 0,54	2.800	0,32 ~ 0,45
10	2.400	0,35 ~ 0,5	3.200	0,35 ~ 0,6	2.500	0,35 ~ 0,5
11	2.200	0,39 ~ 0,55	2.900	0,39 ~ 0,66	2.300	0,39 ~ 0,55
12	2.000	0,42 ~ 0,6	2.700	0,42 ~ 0,72	2.100	0,42 ~ 0,6
13	1.800	0,46 ~ 0,65	2.400	0,46 ~ 0,78	2.000	0,46 ~ 0,65
14	1.700	0,49 ~ 0,7	2.300	0,49 ~ 0,84	1.800	0,49 ~ 0,7
15	1.600	0,53 ~ 0,70	2.100	0,53 ~ 0,75	1.700	0,53 ~ 0,7
16	1.500	0,56 ~ 0,72	2.000	0,56 ~ 0,8	1.600	0,56 ~ 0,72
17	1.400	0,6 ~ 0,77	1.900	0,6 ~ 0,85	1.500	0,6 ~ 0,77
18	1.300	0,63 ~ 0,81	1.800	0,63 ~ 0,9	1.400	0,63 ~ 0,81
19	1.300	0,67 ~ 0,86	1.700	0,67 ~ 0,95	1.300	0,67 ~ 0,86
20	1.200	0,7 ~ 0,9	1.600	0,7 ~ 1	1.300	0,7 ~ 0,9

- The indicated speeds and feeds are for drilling with **water-soluble coolant**.
- Water-soluble high density coolant (less than 20 times dilution) is recommended.
- When using non-water-soluble or water-soluble coolant (over 20 times dilution), reduce cutting speed by 30%.
- Equip the drill with a scratch- and dust-free collet and **minimize drill deflection to less than 0.02mm**.
- Fasten the work material to reduce the possibility of work deformation, deflection of machined surface, or vibration.
- A clogged oil hole can lead to breakage. Make sure that a filter is attached to the oil feeder.

TRS-HO-10D

Vc	Mild Steel - Low Carbon Steel St-52 ~150HB ~500 N/mm ²		Carbon Steel C45 ~210HB ~710 N/mm ²		Alloys Steel 42CrMo4 16~28HRC 710~900 N/mm ²		Alloys Steel 42CrMo4 16~28HRC 900~110 N/mm ²		Cast Iron GG-25 ~350 N/mm ²		Ductile Cast Iron GGG-60 400~600 N/mm ²	
	80 ~ 120 m/min		80 ~ 120 m/min		60 ~ 100 m/min		60 ~ 90 m/min		80 ~ 150 m/min		60 ~ 120 m/min	
Ø	S (min ⁻¹)	F (mm/rev.)	S (min ⁻¹)	F (mm/rev.)	S (min ⁻¹)	F (mm/rev.)	S (min ⁻¹)	F (mm/rev.)	S (min ⁻¹)	F (mm/rev.)	S (min ⁻¹)	F (mm/rev.)
	10D		10D		10D		10D		10D		10D	
5	6.400	0,18 ~ 0,25	6.400	0,18 ~ 0,25	4.800	0,18 ~ 0,25	5.700	0,18 ~ 0,25	6.400	0,18 ~ 0,30	6.400	0,18 ~ 0,25
6	5.300	0,21 ~ 0,30	5.300	0,21 ~ 0,30	4.000	0,21 ~ 0,30	4.800	0,21 ~ 0,30	5.300	0,21 ~ 0,36	5.300	0,21 ~ 0,30
7	4.500	0,25 ~ 0,35	4.500	0,25 ~ 0,35	3.400	0,25 ~ 0,35	4.100	0,25 ~ 0,35	4.500	0,25 ~ 0,42	4.500	0,25 ~ 0,35
8	4.000	0,28 ~ 0,40	4.000	0,28 ~ 0,40	3.000	0,28 ~ 0,40	3.600	0,28 ~ 0,40	4.000	0,28 ~ 0,48	4.000	0,28 ~ 0,40
9	3.500	0,32 ~ 0,45	3.500	0,32 ~ 0,45	2.700	0,32 ~ 0,45	3.200	0,32 ~ 0,45	3.500	0,32 ~ 0,54	3.500	0,32 ~ 0,45
10	3.200	0,35 ~ 0,50	3.200	0,35 ~ 0,50	2.400	0,35 ~ 0,50	2.900	0,35 ~ 0,50	3.200	0,35 ~ 0,60	3.200	0,35 ~ 0,50
11	2.900	0,39 ~ 0,55	2.900	0,39 ~ 0,55	2.200	0,39 ~ 0,50	2.600	0,39 ~ 0,50	2.900	0,39 ~ 0,66	2.900	0,39 ~ 0,55
12	2.700	0,42 ~ 0,60	2.700	0,42 ~ 0,60	2.000	0,42 ~ 0,54	2.400	0,42 ~ 0,54	2.700	0,42 ~ 0,72	2.700	0,42 ~ 0,60

CUSTOM TOOLING

A V A I L A B L E O N R E Q U E S T



PLEASE CONTACT YOUR LOCAL SALES
REPRESENTATIVE FOR DETAILS

ADO-TRS: 3 FLUTES DRILL IS WELL-BALANCED

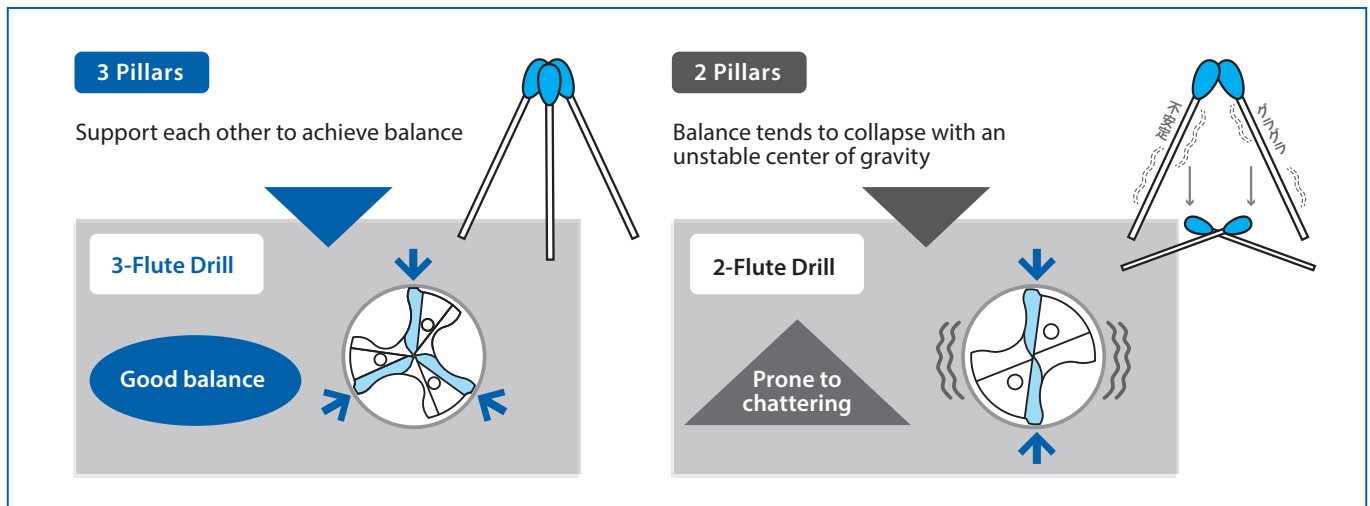

The collapse of balance greatly affects hole quality

		ADO-TRS	Competitor (3FL)	Competitor (2FL)		
Hole Expansion Comparison	Entry	0,005mm	0,051mm	0,025mm		
	Middle	0,002mm	0,039mm	0,022mm		
	Exit	0,003mm	0,05mm	0,018mm		
Roundness Cylindricity	16 μm	28 μm	30 μm	32 μm	52 μm	40 μm

Tool	ADO-TRS	Cutting Speed	90m/min (1.791min ⁻¹)		Coolant	Water Soluble 3MPa
Work Material	SCM420H	Feed	3FL 1,075mm/min (0.6mm/rev)	2FL 537mm/min (0.3mm/rev)	Machine	Horizontal Machining Center

The quality of the pre-drilled hole will affect the performance of the next process such as tapping.

EgiAs Coating

EgiAs coating with high toughness and wear resistance characteristics

Constructed with extreme toughness, high wear and heat resistance characteristics to ensure stable and consistent tool life.

EgiAs

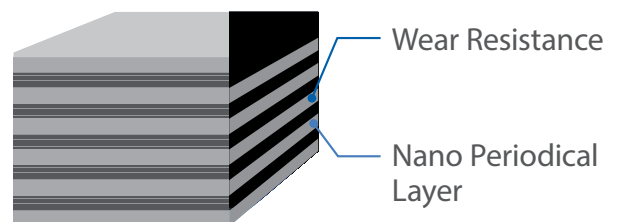

Coating Color	Coating Structure	Hardness (Hv)	Oxidation Temperature (C°)	Heat Resistance	Adhesion Strength	Wear Resistance	Welding Resistance	Toughness
Interference Color	Periodic Nano-layered	40	1.100	☉	☉	☉	☉	☉

Drilling | Solid carbide

CUTTING DATA

Outstanding cutting chip breakage and consistent chip form

Tool	ADO-TRS-5D	Competitor 3FL	Competitor 2FL
Size	Ø 14		
Work Material	S50C		
Cutting Speed	100m/min (2.275min ⁻¹)		
Feed	1,365mm/min (0,6mm/rev)	965mm/min (0,42mm/rev)	
Depth of Hole	70mm (Blind)		
Coolant	Water Soluble		
Machine	Horizontal Machining Center		

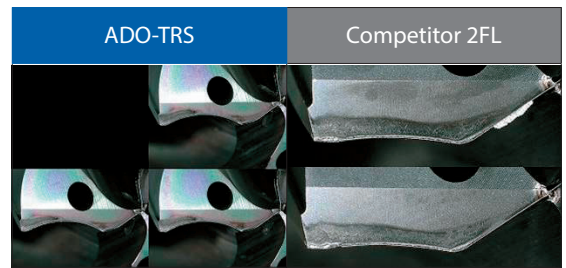

	Number of holes			
	500	1.000	1.500	
ADO-TRS	1.600 (Holes)			Still Running
Competitor 3FL	100 (Holes)	Breakage		
Competitor 2FL	1.400 (Holes)		Chipping	



Stable performance with trouble-free chip evacuation even in SS400

Tool	ADO-TRS-5D
Size	Ø 8,5
Work Material	SS400
Cutting Speed	100m/min (3.745 min ⁻¹)
Feed	1,273mm/min (0,34mm/rev)
Depth of Hole	43mm (Blind)
Coolant	Water Soluble 3MPa
Machine	Horizontal Machining Center

	Number of holes			
	1.000	2.000	3.000	
ADO-TRS	2.900 (Holes)			Still Running
Competitor 3FL	1 (Hole)	Tangled chips at early stage		
Competitor 2FL	290 (Holes)	Tool breakage due to tangled chips		

Smooth chip evacuation capability enables long and stable tool life in SS400, a material prone to the elongation of chips

CUTTING DATA

Demonstrates low resistance characteristic in thin plate processing

Tool	ADO-TRS-3D	Competitor 3FL	Competitor 2FL
Size	Ø 14		
Work Material	S53C (30HRC)		
Cutting Speed	100m/min (2.275min ⁻¹)		
Feed	1,274mm/min (0,56mm/rev)	956mm/min (0,42mm/rev)	
Depth of Hole	100mm (Through)		
Coolant	Water Soluble		
Machine	Vertical Machining Center		

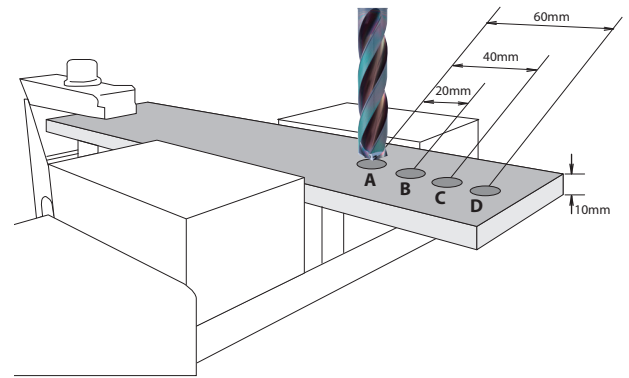

Hole precision equivalent to low-feed 2-flute drills

Tool	Feed	Hole Position Accuracy				Hole Diameter			
		A	B	C	D	A	B	C	D
ADO-TRS	1.274mm/min	0,031	0,033	0,038	0,042	13,996	13,998	14,009	14,022
Competitor (3FL)	1.274mm/min	0,055	0,075	0,131	0,272	14,004	14,007	14,020	14,062
Competitor (2FL)	956mm/min	0,023	0,029	0,045	0,046	14,013	14,021	14,026	14,026

Comparison of tapping performance based on quality of pre-drilled holes

A close-up on the differences between tapping in a good quality pre-drilled hole and a poor quality pre-drilled hole with significant deviation.

Size	M6 X 1	Cutting Speed	15m/min (1.791min ⁻¹)	Coolant	Water Soluble 3MPa
Work Material	S50C	Tapping Length	12mm	Machine	Horizontal Machining Center

Cutting Tap (Drill hole size: Ø 5 x 15mm)

Good pre-drilled hole quality	Poor pre-drilled hole quality
	<p>Unstable chip generation with various thickness</p> <p>➔ Risk of breakage, poor thread accuracy</p>

Forming Tap (Drill hole size: Ø 5,52 x 15mm)

Good pre-drilled hole quality	Poor pre-drilled hole quality
	<p>Tapping torque sharply increases in the latter half of machining</p> <p>➔ Risk of breakage, poor thread accuracy</p>



CUTTING DATA

Crankshaft (alloy steel) cycle time reduction example

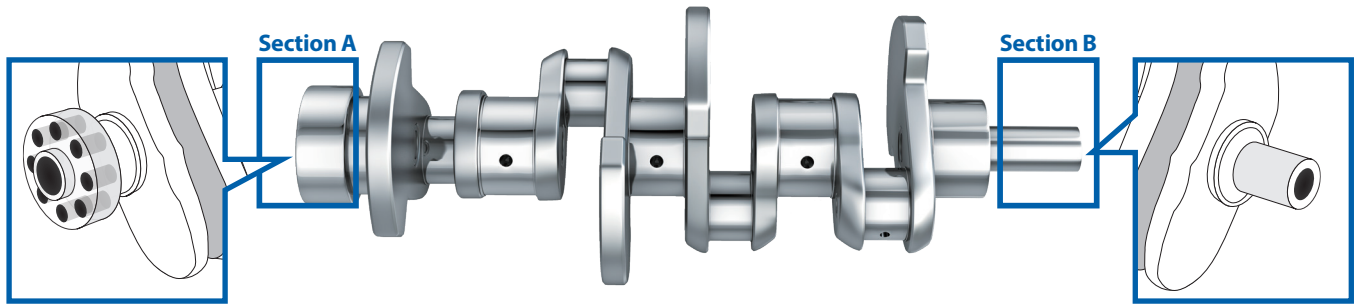

Section A

Tool	ADO-TRS Special	Competitor 2FL
Size	Ø 8,8	
Work Material	Alloy Steel	
Cutting Speed	80m/min (2.895min ⁻¹)	
Feed	1,563mm/min (0,54mm/rev)	347mm/min (0,12mm/rev)
Coolant	MQL	
Machine	Horizontal Machining Center	

Section B

Tool	ADO-TRS Special	Competitor 2FL
Size	Ø 12,5	
Work Material	Alloy Steel	
Cutting Speed	80m/min (2.038min ⁻¹)	
Feed	1,101mm/min (0,54mm/rev)	408mm/min (0,2mm/rev)
Coolant	MQL	
Machine	Horizontal Machining Center	



	Number of holes		
	2.000	4.000	6.000
ADO-TRS	6.400 (Holes)		Still Running
Competitor 2FL	3.200 (Holes)	Tool Change	

	Number of holes		
	1.000	2.000	3.000
ADO-TRS	3.000 (Holes)		Still Running
Competitor 2FL	1.500 (Holes)	Tool Change	

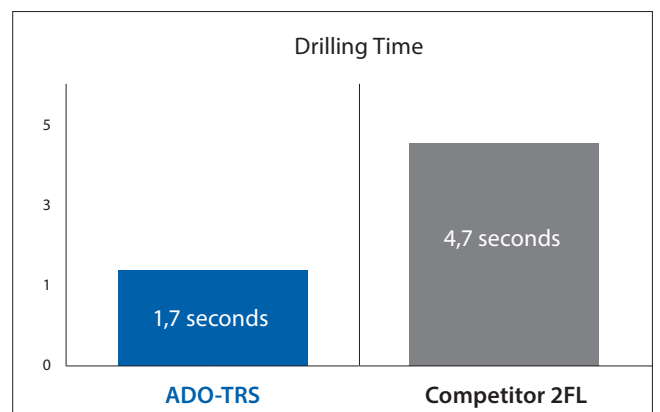
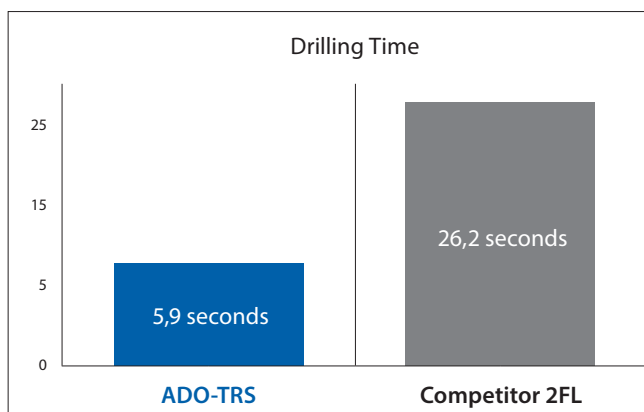

CUTTING DATA

Breaks chips into small manageable pieces even in SCM440 with MQL

Tool	ADO-TRS-5D
Size	Ø5
Work Material	SCM440(30HRC)
Cutting Speed	75m/min (4.777 min ⁻¹)
Feed	1,194mm/min (0,25mm/rev)
Depth of Hole	25mm (Through)
Coolant	MQL
Machine	Horizontal Machining Center

	Number of Holes		
	1.000	2.000	3.000
ADO-TRS	3.000 (Holes) Still Running		
Competitor 3FL	500 (Holes) Tangled chips		

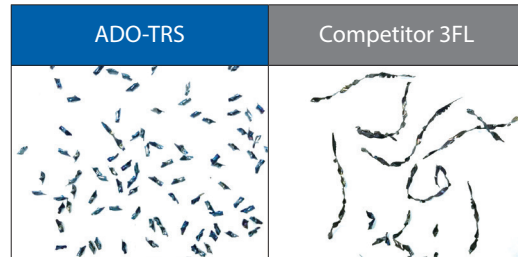

The competitor ejected long cutting chips that tangled around the tool. The ADO-TRS, on the other hand, is able to achieve trouble-free drilling by breaking cutting chips into small manageable pieces

Excellent chip evacuation even in deep hole drilling on a lathe machine

Tool	ADO-TRS-8D Special
Size	Ø14
Work Material	Alloy Steel
Cutting Speed	80m/min (1.820 min ⁻¹)
Feed	946mm/min (0,52mm/rev)
Depth of Hole	90mm
Coolant	Water Soluble
Machine	Lathe (rotating workpiece)

	Number of Holes		
	1.000	3.000	5.000
ADO-TRS	4.950 (Holes) Still Running		
Competitor 3FL	4.000 (Holes) Breakage		

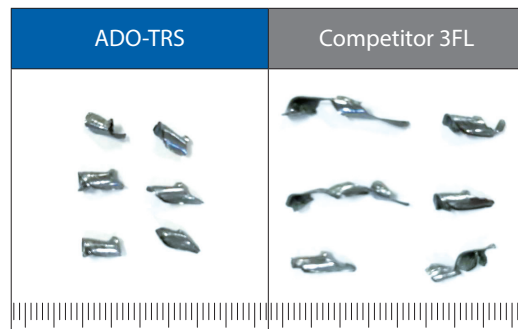

Demonstrates stable chip evacuation even in deep hole drilling of a rotating workpiece that is difficult to discharge chips





shaping your dreams

OSG EUROPE LOGISTICS

Avenue Lavoisier 1
B-1300 Z.I. Wavre - Nord - Belgium
Tel: +32 10 23 05 07
Fax: +32 10 23 05 51
info@osgeurope.com

OSG BELUX

Avenue Lavoisier 1
B-1300 Z.I. Wavre - Nord - Belgium
Tel: +32 10 23 05 11
Fax: +32 10 23 05 31
info@osg-belgium.com

OSG FRANCE

Parc Icade, Paris Nord 2
Immeuble "Le Rimbaud"
22 Avenue des Nations
CS66191 - 93420 Villepinte - France
Tel: +33 1 49 90 10 10
Fax: +33 1 49 90 10 15
sales@osg-france.com

OSG NETHERLANDS

Bedrijfsweg 5 - 3481 MG Harmelen
Tel: +31 348 44 2764
Fax: +31 348 44 2144
info@osg-nl.com

OSG UK

Kelsey Close, Attleborough Fields Ind Est,
CV11 6RS, Nuneaton, United Kingdom.
Tel: +44 1827 720 013
uk_sales@osg-uk.com

CZECH, SLOVAKIA, HUNGARY

OSG Europe Logistics S.A.
Slovakia organizacna zlozka
Racianská 22/A, SK-83102 Bratislava
Slovakia
Tel. +421 24 32 91 295
Orders-osgsvk@osgeurope.com

OSG POLAND Sp. z.o.o.

Spółdzielcza 57
05-074 Halinów - Poland
Tel: +22 760 82 71
Fax: +22 760 82 71
osg@osg-poland.com

OSG GERMANY

Karl-Ehmann-Str. 25
D - 73037 Göppingen - Germany
Tel: +49 7161 6064 - 0
Fax: +49 7161 6064 - 444
info@osg-germany.de

OSG SCANDINAVIA

(For Scandinavian countries)
Langebjergvaenget 16
4000 Roskilde - Denmark
Tel: +45 46 75 65 55
Fax: +45 46 75 67 00
osg@osg-scandinavia.com

SWEDEN

Branch office of OSG SCANDINAVIA
Singelgatan 7
212 28 Malmö - Sweden
Tel: +46 40 41 22 55
osg@osg-scandinavia.com

OSG IBERICA

Bekolarra 4
E - 01010 Vitoria-Gasteiz - Spain
Tel: +34 945 242 400
Fax: +34 945 228 883
osg.iberica@osg-ib.com

RUSSIA

Butlerova street, 17B, office 5069
117342 Moscow - Russia
Tel: +7 (495) 150 41 54
info@osg-russia.com

OSG TURKEY

Rami Kişla Cad.No:56 Eyüp
Istanbul 34056 - Turkey
Tel:+90 212 565 24 00
Fax: +90 212 565 44 00
info@osg-turkey.com

ROMSAN INTERNATIONAL CO. SRL

Reprezentant Exclusiv OSG
25C, Bucuresti-Magurele Street
051431 Bucuresti - România
Tel: +40 21 322 07 47
Fax: +40 21 321 56 00
romsan.int@romsan.ro

AUSTRIA

Branch office of OSG GERMANY
Messestraße 11
A-6850 Dornbirn
Tel: +49 7161 6064-0
Fax: +49 7161 6064-444
info@osg-germany.de

OSG ITALIA

Via Ferrero, 65 A/B3
I - 10098 Rivoli - Italy
Tel: +39 0117705211
Fax: +39 0117705215
info@osg-italia.it

Vischer & Bolli AG

Machining and Workholding
Im Schossacher 17
CH-8600 Dübendorf
T +41 44 802 15 15
F +41 44 802 15 95
info@vb-tools.com

OSG EUROPE LOGISTICS S.A.

01/2022 - All rights reserved. © OSG Europe 2022

The contents of this catalogue are provided to you for viewing only. They are not intended for reproduction either in part or in whole in this or other medium. They cannot be copied, used to create derivation work or used for any reason, by means without the express, written permission of the copyright owner. If prices are stated, they are netto unit-prices and any eventual tax(es) have to be added. The company is not responsible for any printing error in technical, price and/or any other data.

Tool specifications subject to change without notice.

www.osgeurope.com